

# Smart Switch MT1

## User Manual

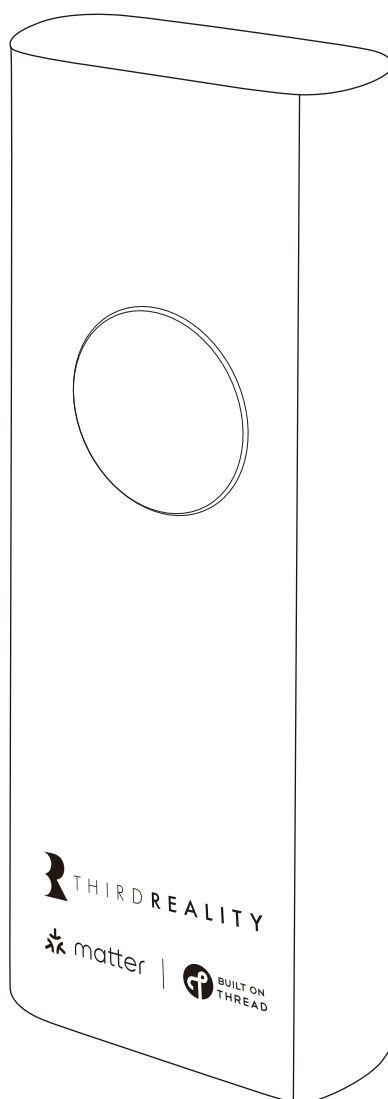

THIRDREALITY

# Contents

|                                  |    |
|----------------------------------|----|
| What's in the Box .....          | 01 |
| Installation .....               | 02 |
| Setup with Apple Home .....      | 06 |
| Setup with Home Assistant .....  | 09 |
| Setup with Google Home .....     | 12 |
| Setup with SmartThings .....     | 16 |
| Troubleshooting .....            | 19 |
| FCC Regulatory Conformance ..... | 20 |

# What's in the Box

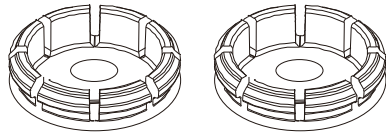
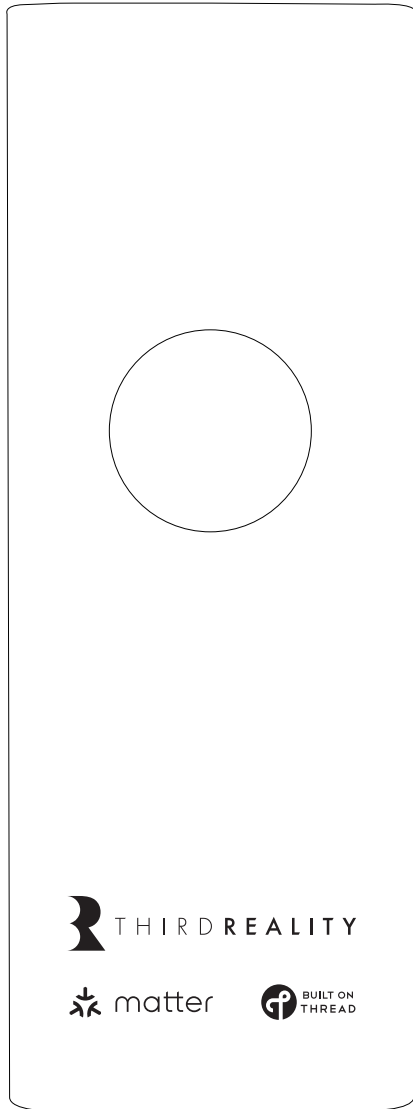

Fastener x2

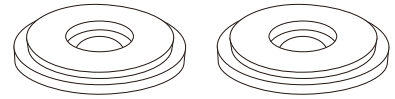

Thin Spacer x2

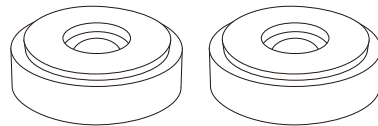

Thick Spacer x2

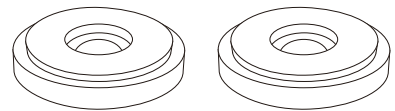

Medium Spacer x2

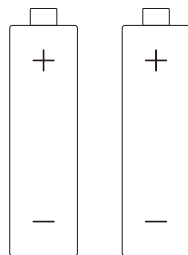

Battery x2

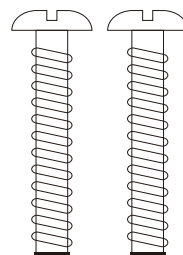

Screw x2

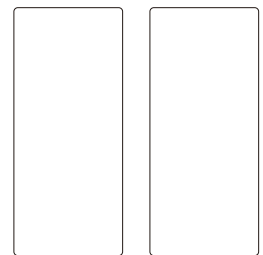

Protective Film x2

Smart Switch MT1

# Installation

- ① Remove screws from the switch panel.

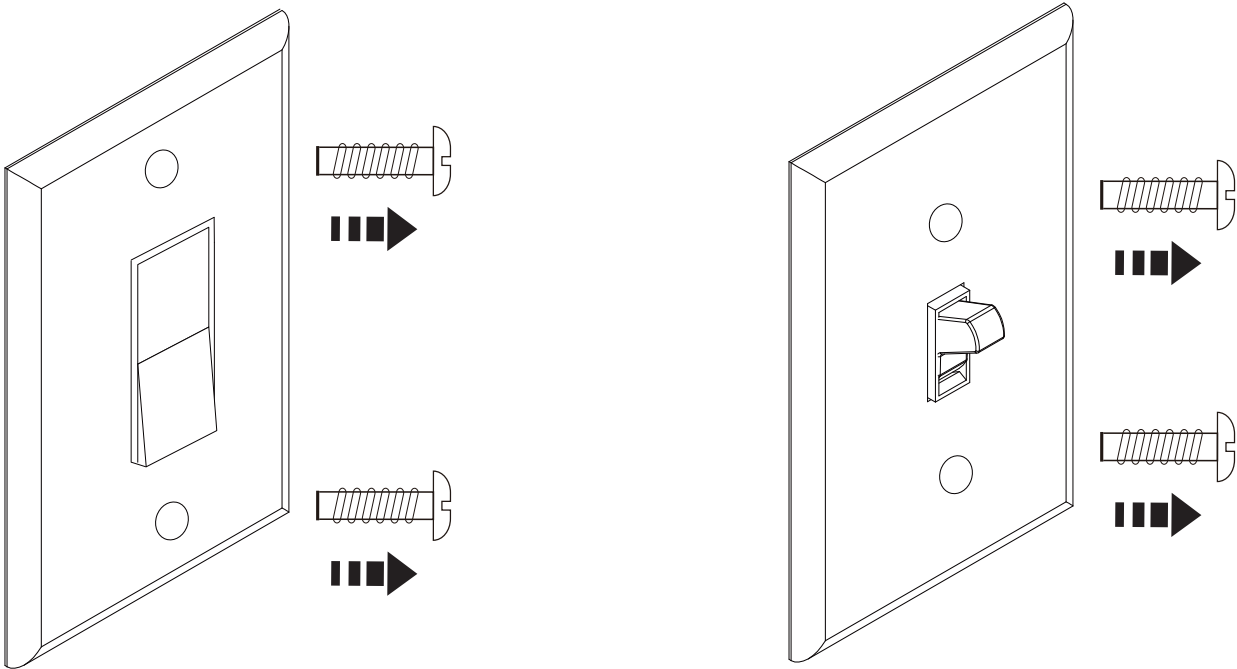

- ② For rocker switches, choose the fasteners and spacers indicated in the form below.

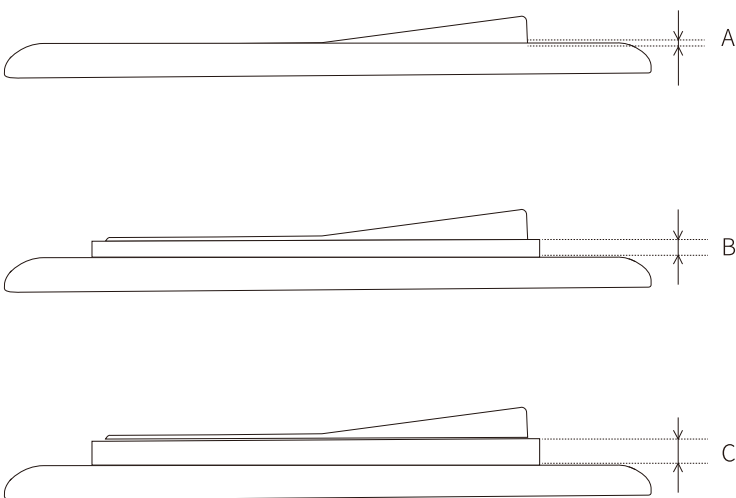

|               |              |
|---------------|--------------|
| A: -0.5mm~1mm | No Spacer    |
| B: 1mm~2.5mm  | Thin Spacer  |
| C: 2.5mm~4mm  | Thick Spacer |

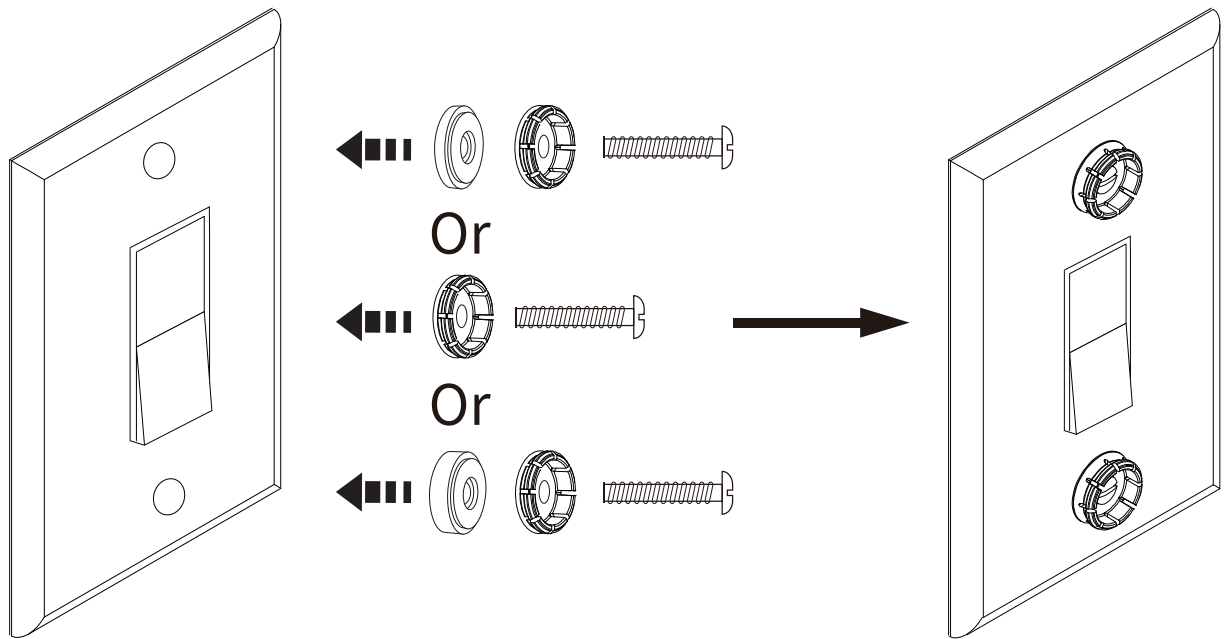

③ Insert two AAA batteries and put the battery cover back.

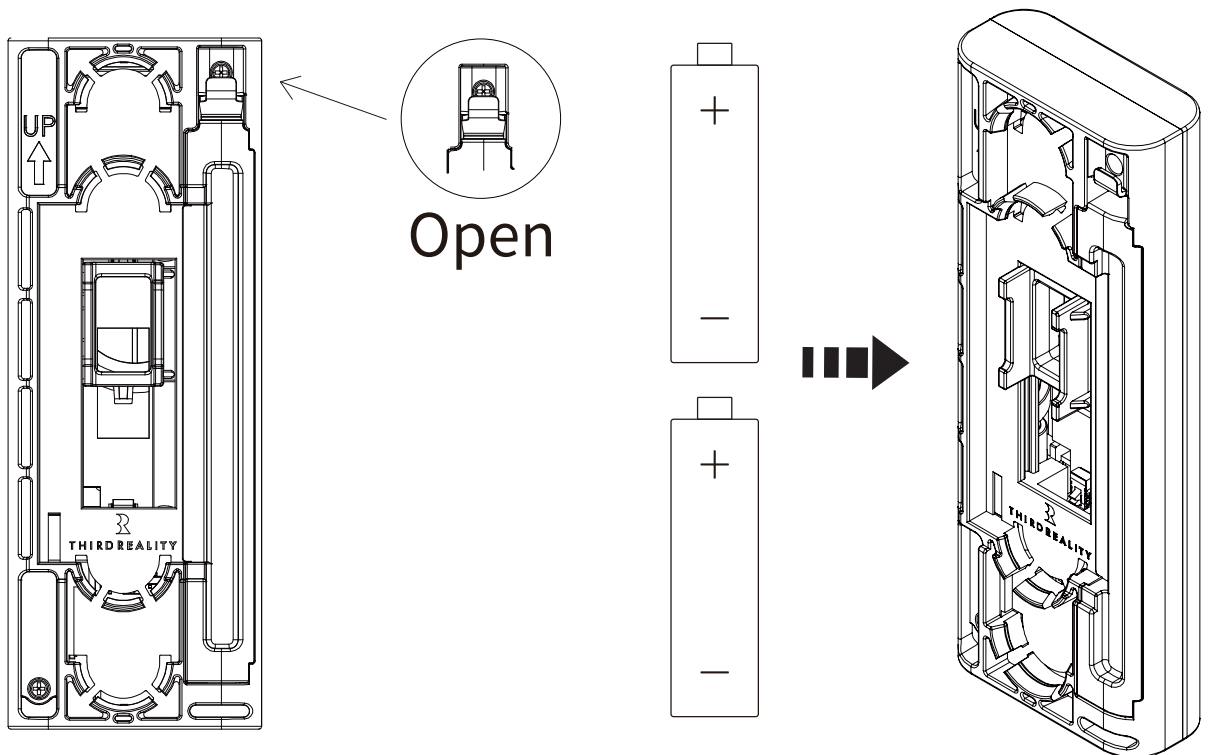

#### ④ Pairing Instructions

1. Position the switch close to your Matter controller.(Make sure the controller supports the Thread)
2. Press and hold the button on the switch for at least 20 seconds. Release when the LED starts flashing rapidly – this means the device is in pairing mode.
3. Open your Matter Platform app and start the "Add Matter Device" process:  
Preferred: Scan the Matter QR Code found on the device's packaging or in the manual.
4. Alternative: Enter the Manual Code printed on the back of switch. Once added, the switch will join your Thread network and appear in your smart home app.

- ⑤ Make sure the Smart Switch actuator is in the up position, as the figure shown below:

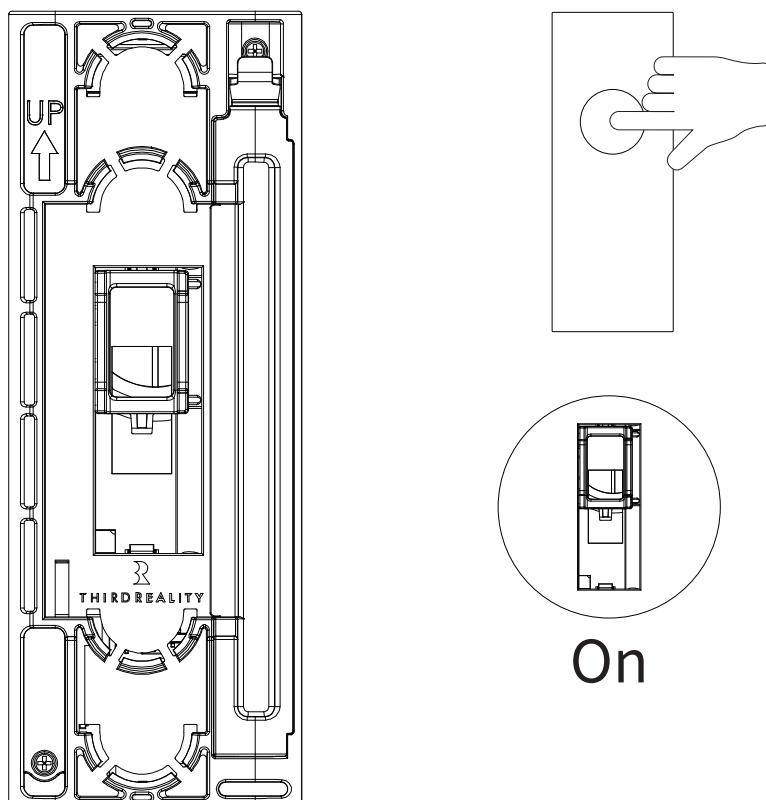

- ⑥ Turn your rocker or toggle switch to the ON position as shown:

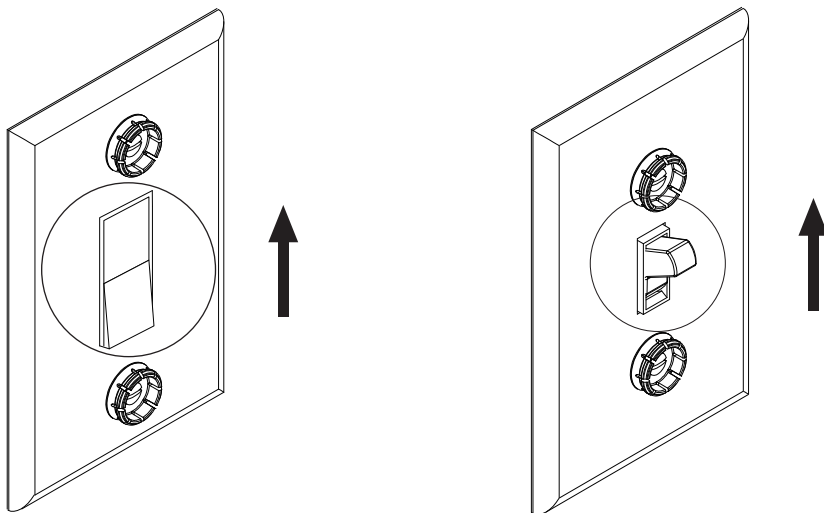

- ⑦ Line up the Smart Switch with the existing switch and click it in. Test its functionality by pressing the button to turn on and off. Adjust the spacers if needed to ensure the Smart Switch properly engages with the wall switch.

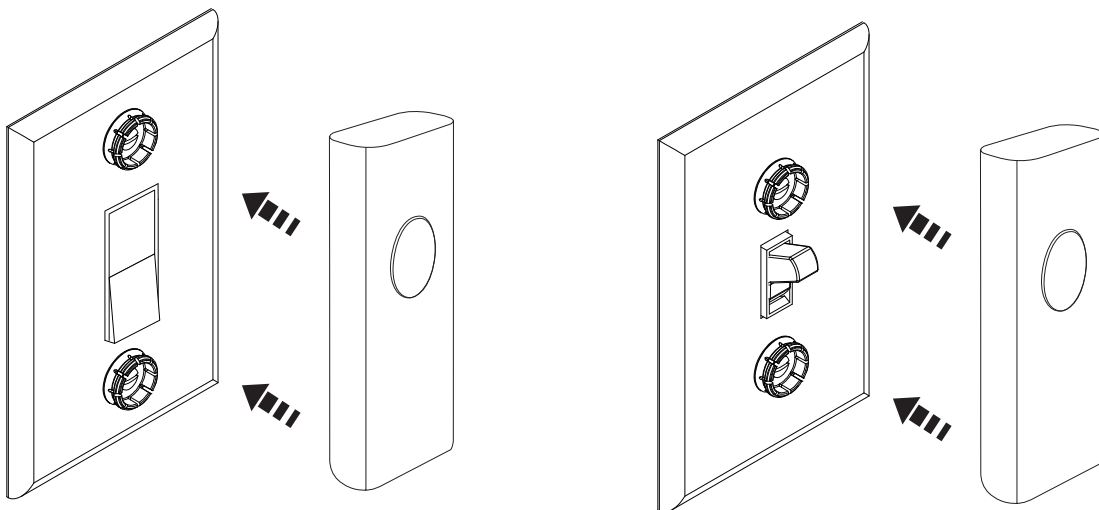

Optional: For the rocker switch, apply a protective film over the paddle to prevent scratches, as illustrated.

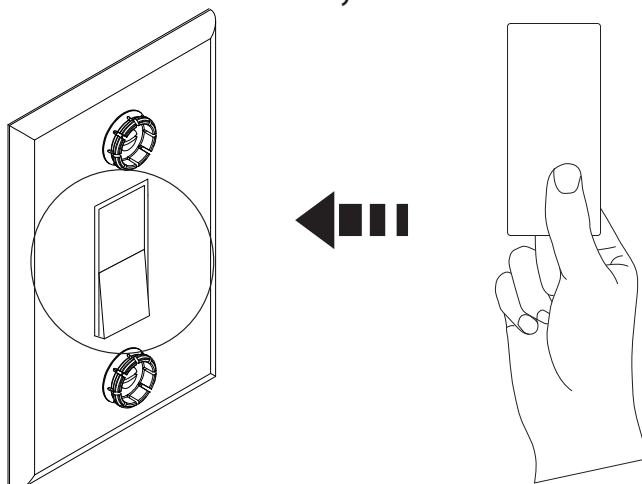

# Setup with Apple Home



Make sure your Apple Home setup includes a hub that supports Thread, such as HomePod mini or a supported third-party border router.

1. Press the button for at least 20 seconds until the light flashes rapidly to put the switch into pairing mode.
2. Launch your Home App. Tap + and choose "Add or Scan Accessory" to add a new device.
3. Scan the QR code on the manual.
4. Choose a location and set a name for your device.
5. Now you can check your device on the Device list, turn it on/off, and create automation with the switch.
6. To connect the device with another Thread-certified ecosystem app, please go to the Device Settings page, scroll to the bottom, and tap "Turn On Pairing Mode" and then "Copy Code." After that, launch the app you want to pair, follow the setup instructions to enter the setup code, and follow the app instructions to complete the setup.

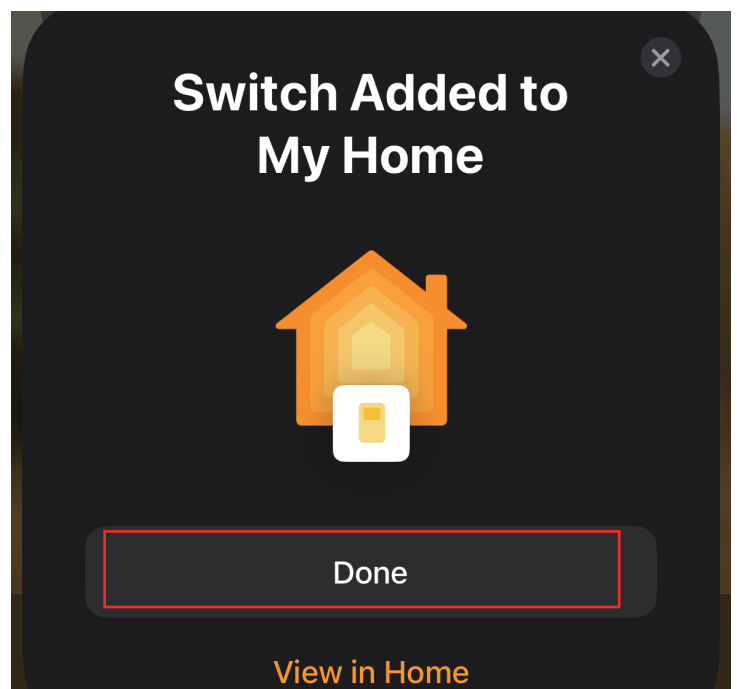
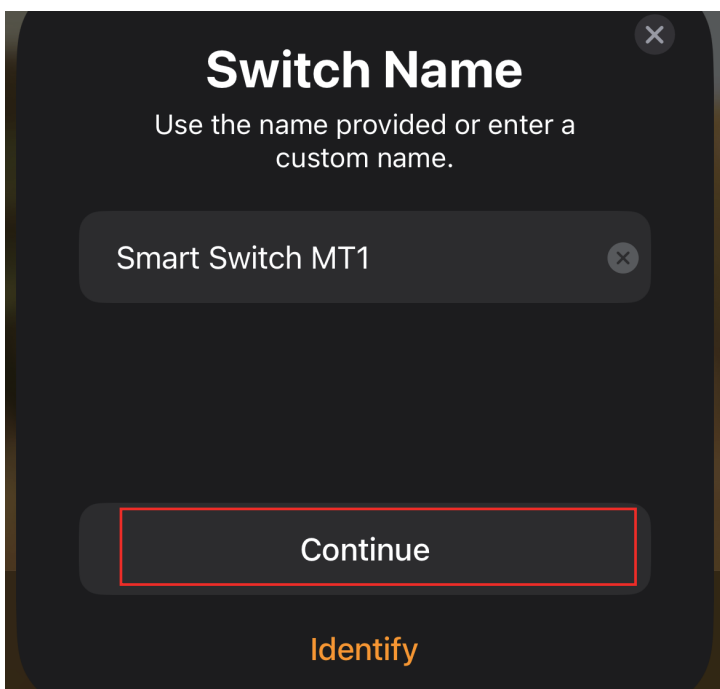
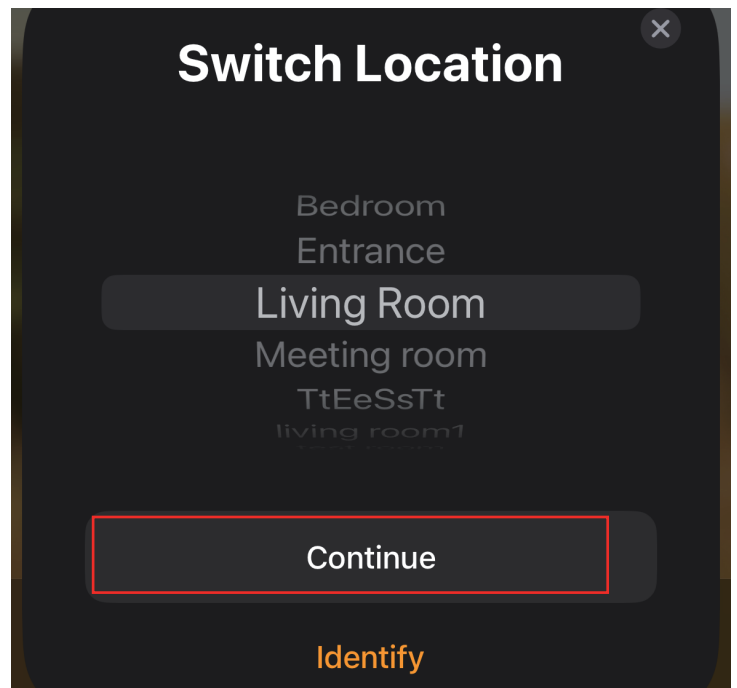
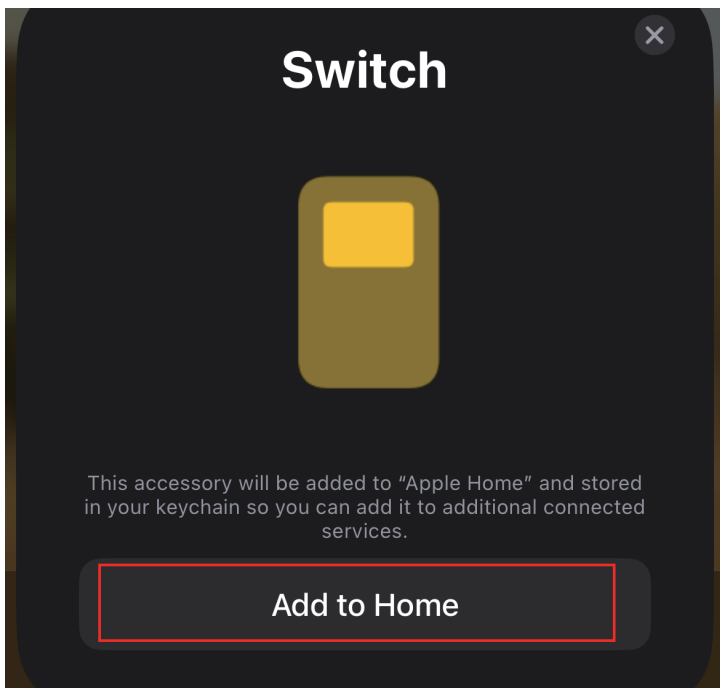
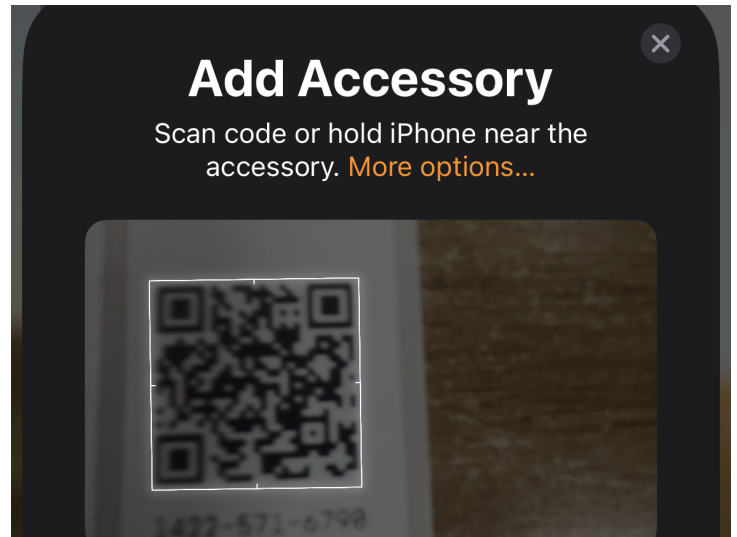
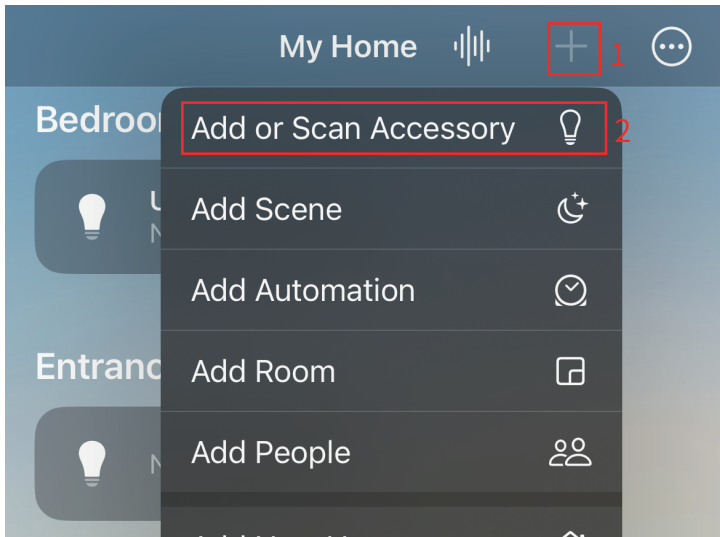

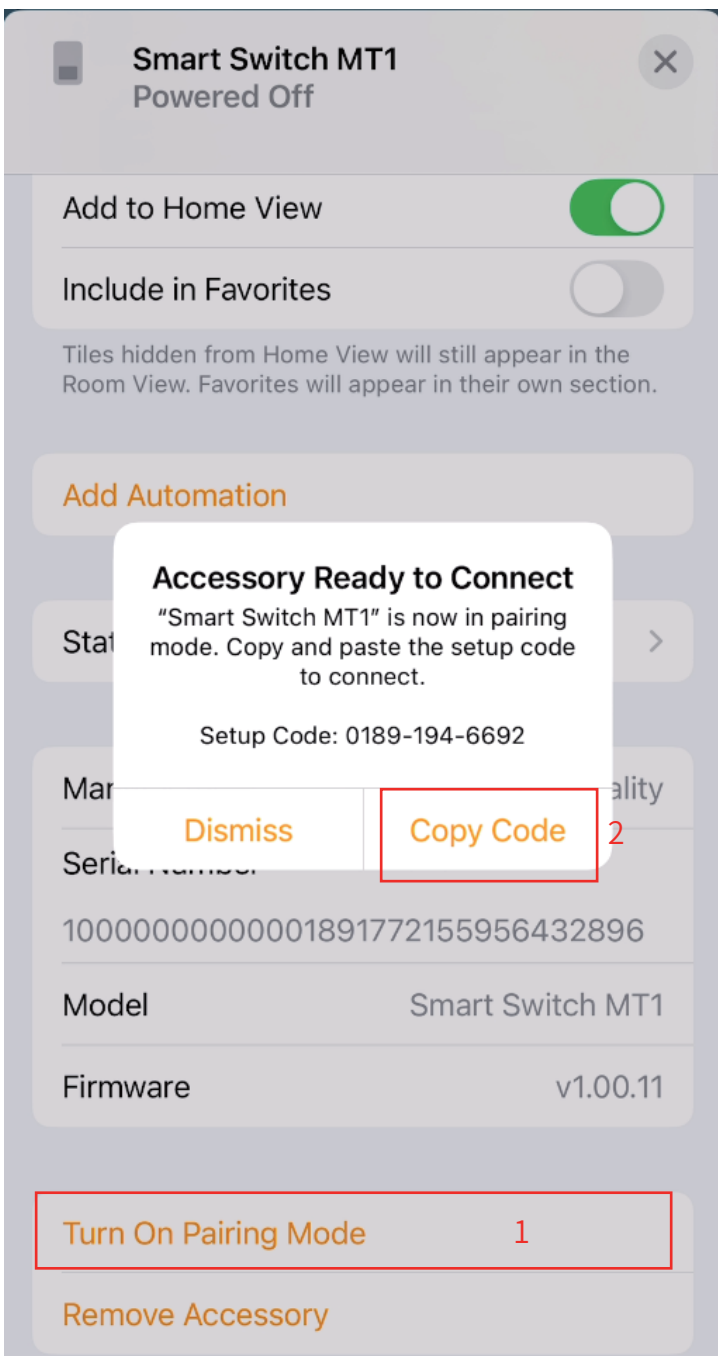
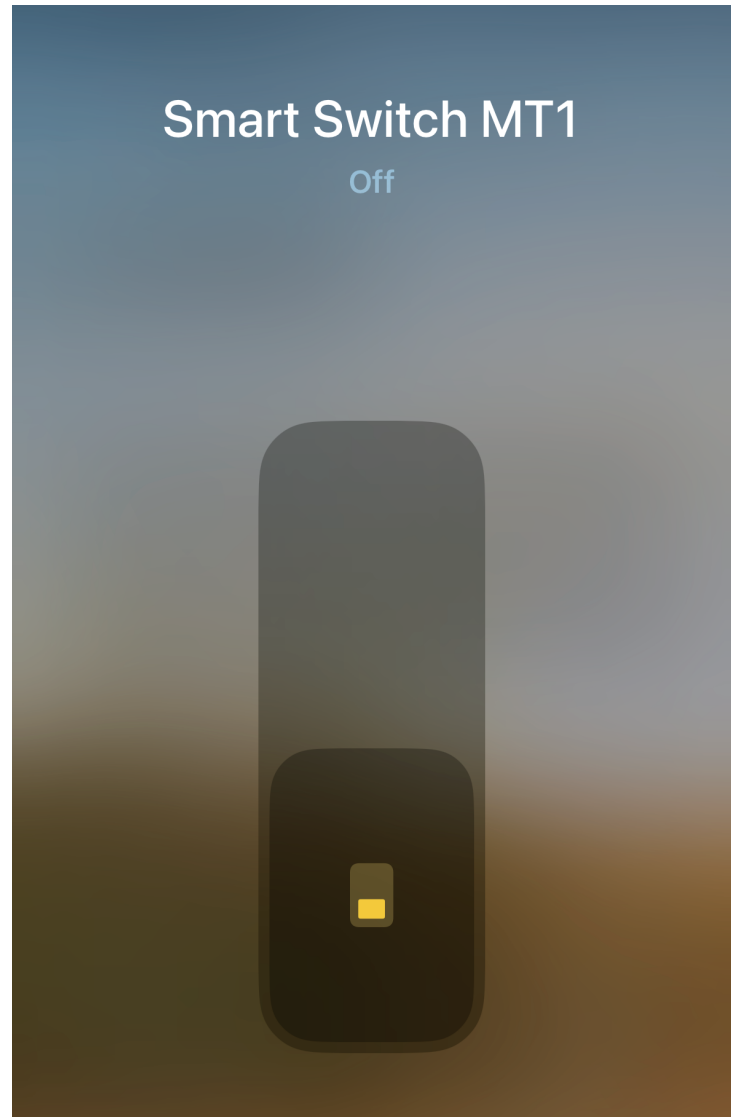

# Setup with Home Assistant



If you have an Apple iPhone and one or more Apple devices that can be utilized by Home Assistant as a Thread Border router: HomePod gen2, HomePod Mini, Apple TV 4K (with ethernet).

If you have an Android phone and one or more Google devices that can be utilized by Home Assistant as a Thread Border router: Google Nest Hub v2, Google Nest Hub Max, Google Nest Wi-Fi Pro.

1. Press the button for at least 20 seconds until the light flashes rapidly to put the switch into pairing mode.
2. Launch the Home Assistant App/ Web control panel.
3. Select "Devices & services" - "Add Matter device."
4. Then choose "No, it's new." to add the switch as a new device.
5. If you are using a phone app, you can directly scan the QR pairing code in the user manual to add the switch. If you are using a Web control panel, you can choose "Setup without QR code" to manually enter the pairing code located on the back of the switch.
6. After setting up the switch, you can turn it on or off through the device panel and set up automation.

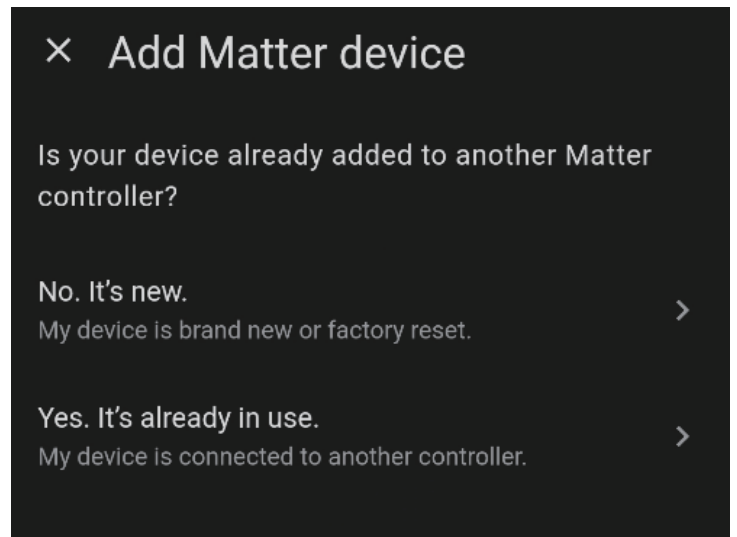
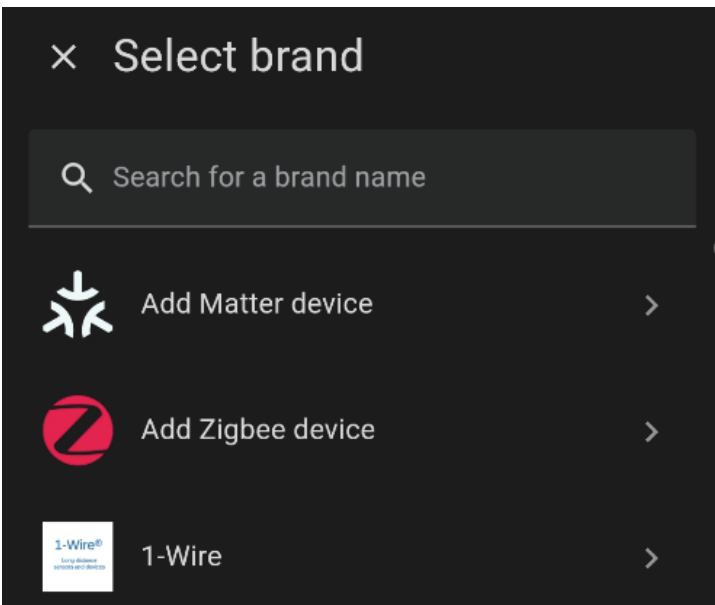
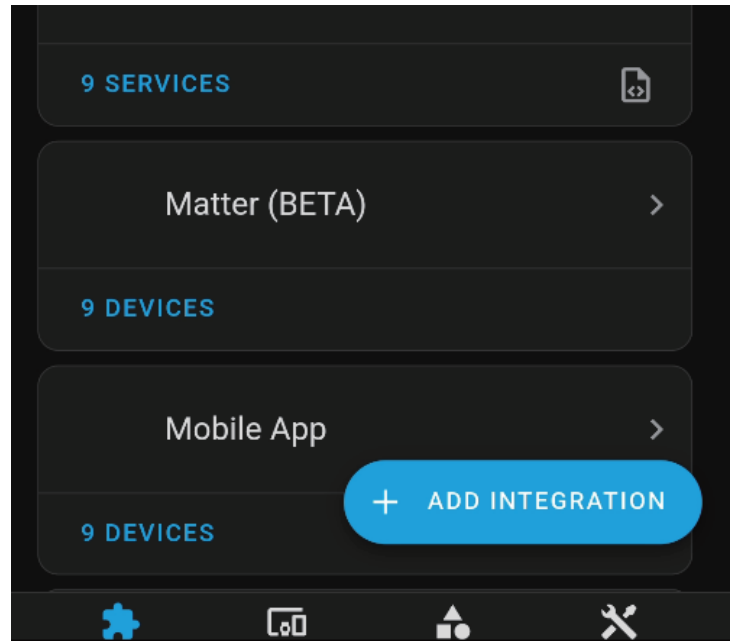
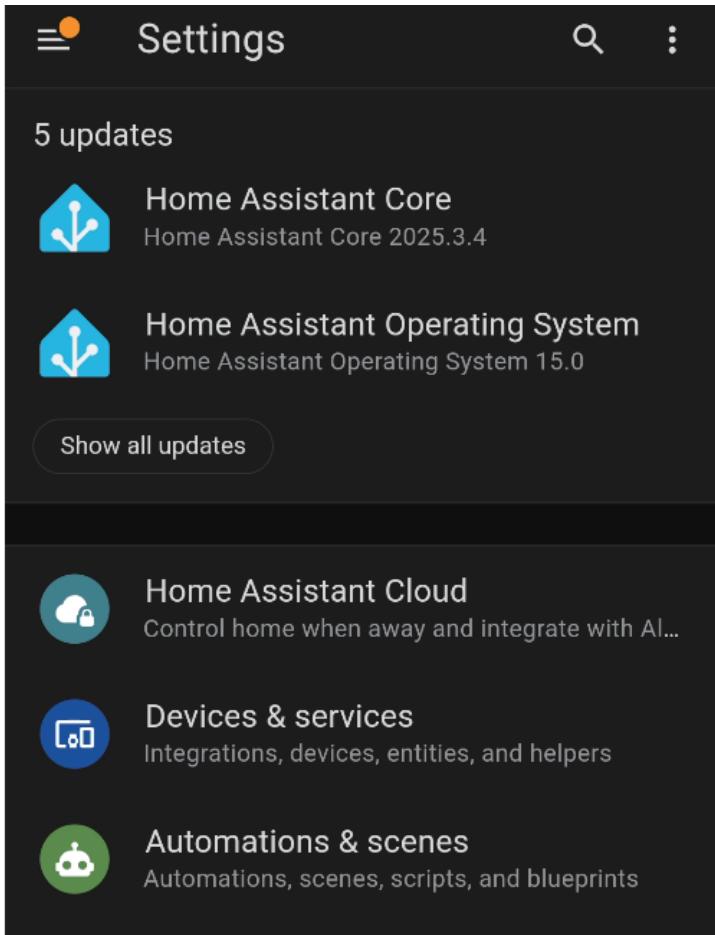

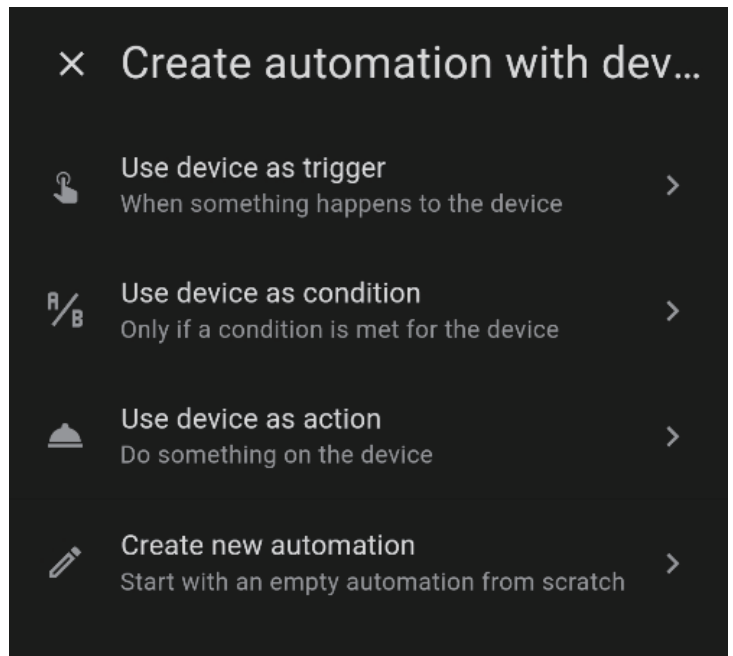
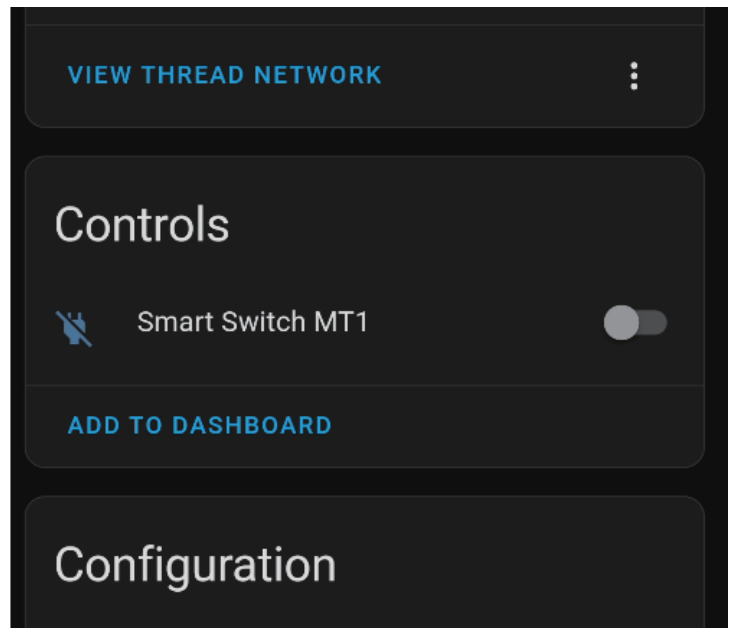
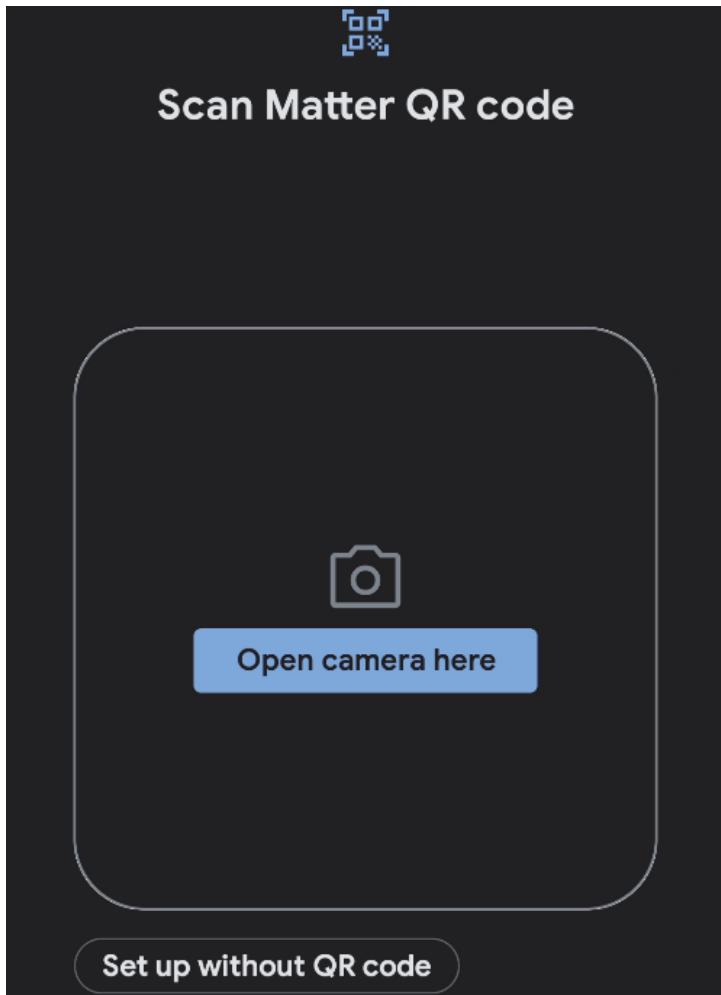

# Setup with Google Home



Make sure your Google Home setup includes a hub that thread board router build in, such as Nest Hub Gen2, Nest Hub Max.

1. Set up your Google Home Speaker in the Google Home App and connect your phone to your Wi-Fi with a 2.4G signal.
2. Hold the button for at least 20 seconds until the LED indicator flashes rapidly, indicating that the switch has entered pairing mode.
3. Your Google Home App will display a notification titled "Set up your device." Tap "Scan QR code" and follow the instructions to add the switch.
4. You can control the switch and create routines with it.
5. To connect the switch to another Thread ecosystem app, open the device page and tap the setting icon on the upright. Then tap "Linked MATTER apps & services" and "Copy pairing code." Launch another Thread-certified ecosystem app, follow the setup instructions to enter the setup code, and complete the setup.

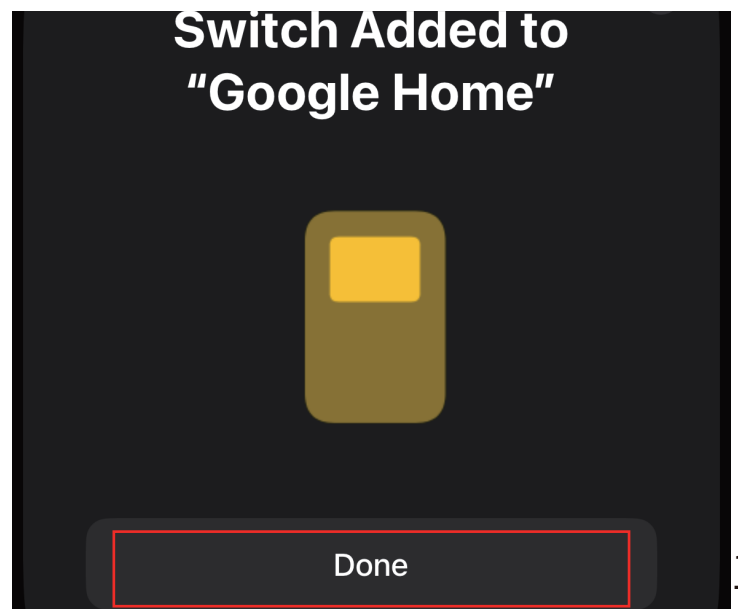
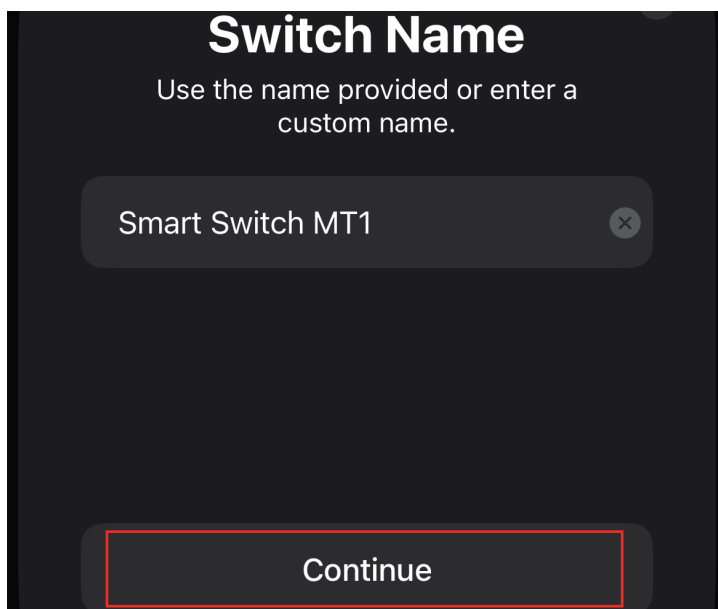
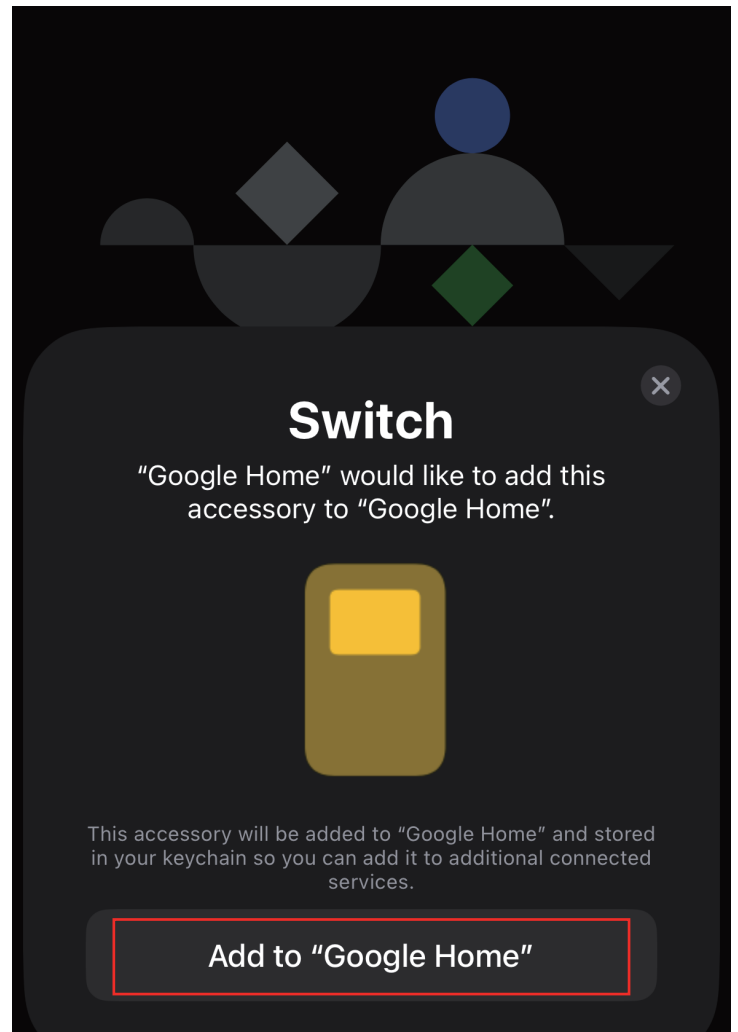
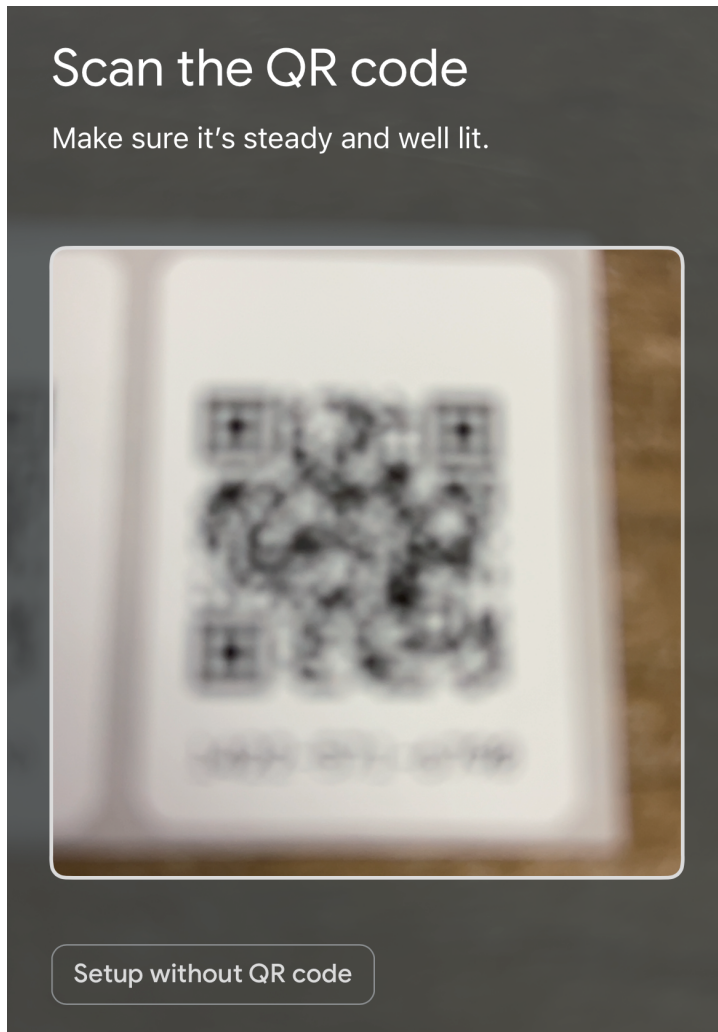
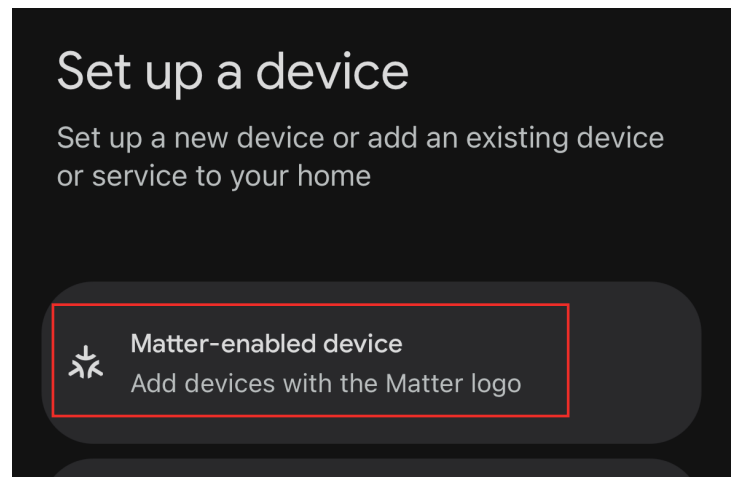
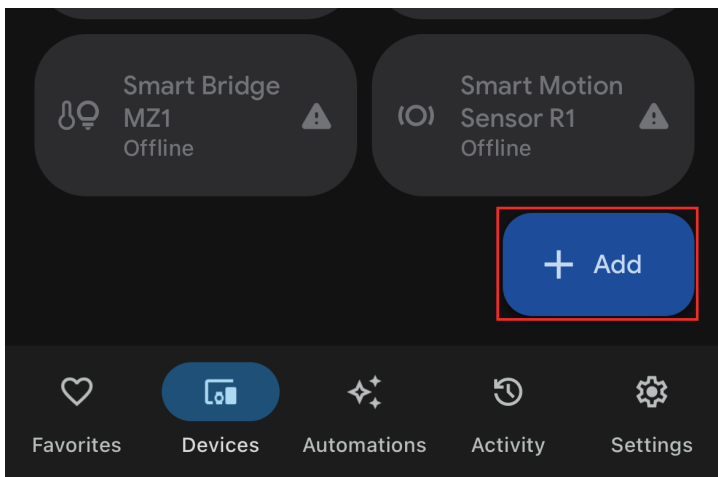

## Where is this device?

Choose a location for your . This will help you organize your devices.

### My rooms

Kitchen

Living Room



## Devices

T

### Living Room

Smart Bridge  
MZ1  
Offline

Smart Switch  
MT1  
Off

### Office

## Smart Switch MT1



Off

### General

#### Name

Smart Switch MT1

#### Device type

Switch

#### Home

Home

#### Room

Living Room

#### Linked Matter apps & services

Can control and manage this device

#### Technical information

Wi-Fi, model, versions, more

# Linked Matter apps & services

You can control and manage this device with these Matter-enabled apps & services

 [Link apps & services](#)

Linked apps & services (2)

Vendor ID: 1384 

Vendor ID: 6006 

Android, Google Home, Google Assistant

 [Unlink all Matter apps & services from this device](#)

 When you unlink a Matter app or service, you can no longer use it with this device. Other connection types might still have access.

## Use pairing code to link

Copy this code, open a Matter-enabled app, and enter the code when prompted. This code expires in 15 minutes.

04844247196

Copy pairing code

# Setup with SmartThings



Make sure your SmartThings setup includes a hub that supports Thread. Such as: SmartThings Station, Aeotec Hub.

1. Launch your SmartThings App and tap + to Add device. Choose Matter.
2. Hold the button for at least 20 seconds until the LED indicator flashes rapidly, indicating that the switch has entered pairing mode.
3. Scan the QR code on the manual.
4. Select a hub to connect your device. (You need to add to "iCloud Account" in IOS, then create an Accessory Name, then Continue)
5. Now, you can check your device on the Device list, turn it on/off, and create routines.
6. To connect the switch to another Thread-certified ecosystem app, go to the Device Setting page, tap "Share with other services," and "QR code," and then "Copy code." Launch the app of another Thread-certified ecosystem, follow the setup instructions to enter the setup code, and follow the app instructions to complete the setup.

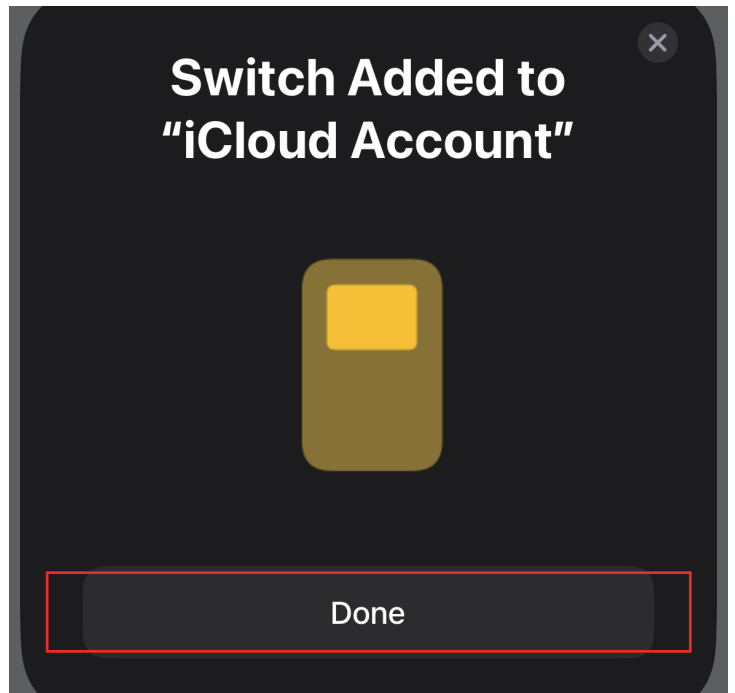
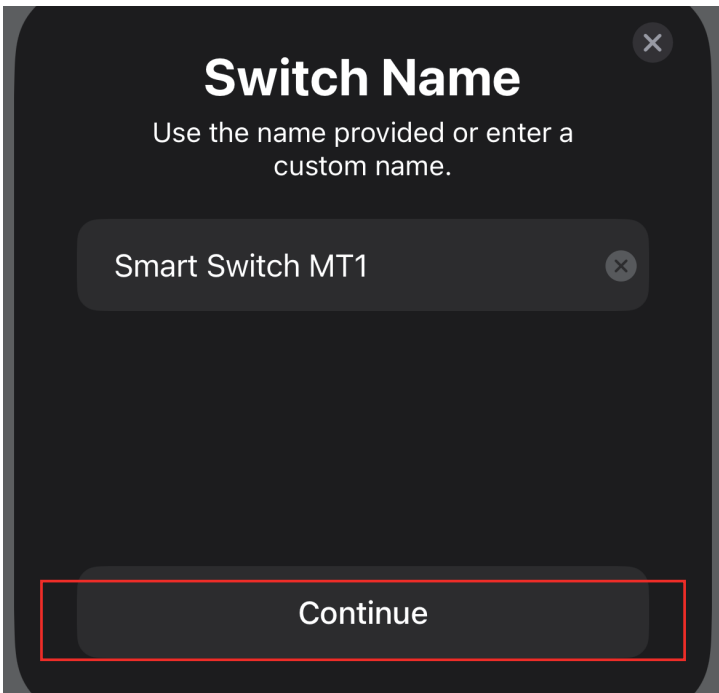
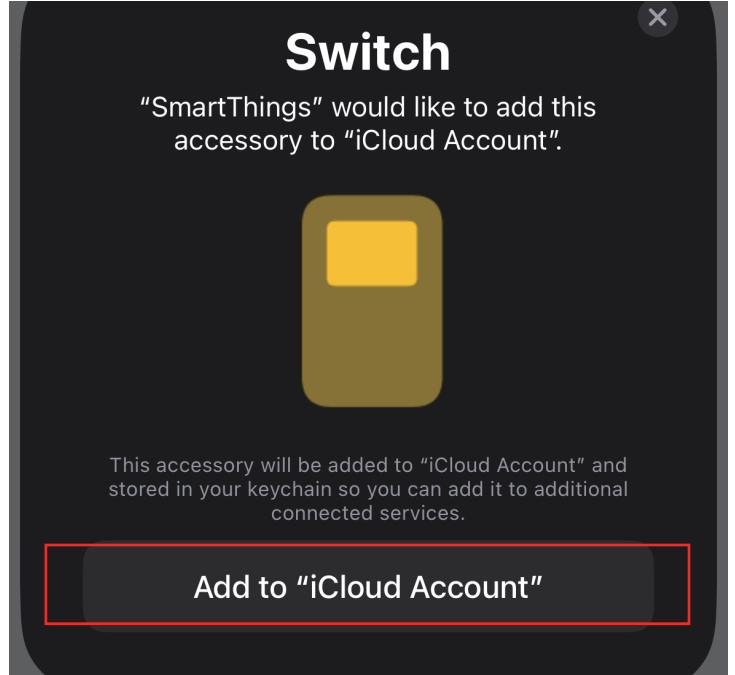
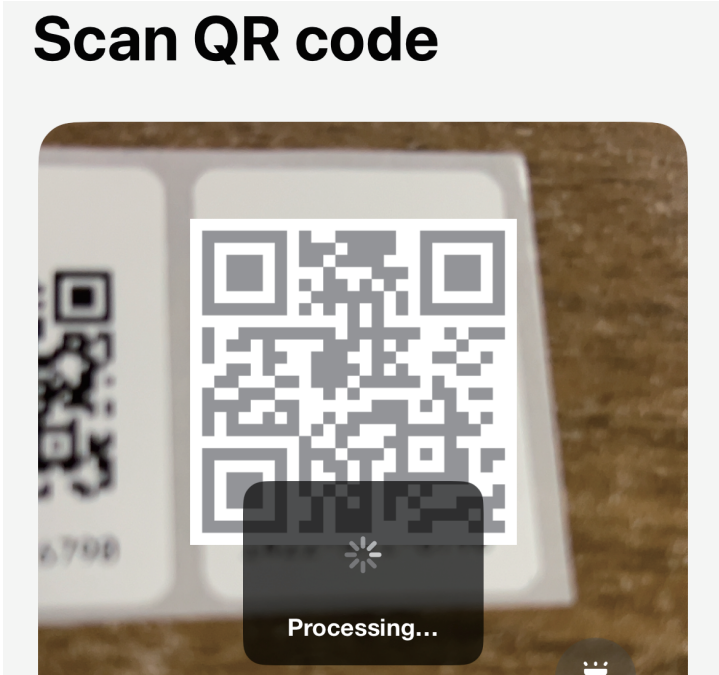
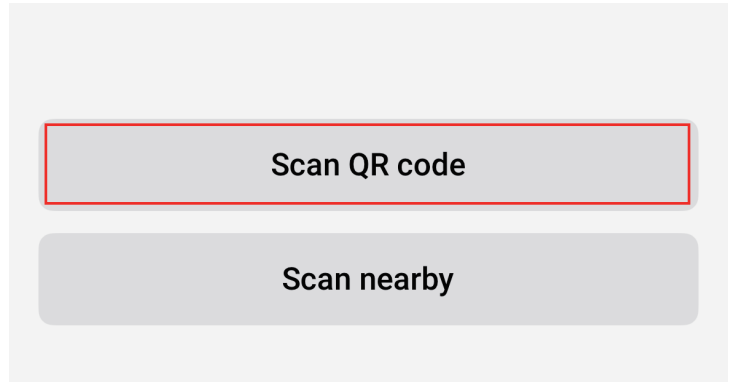
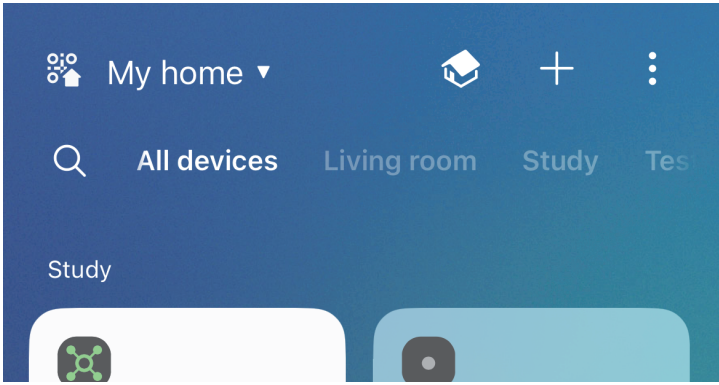

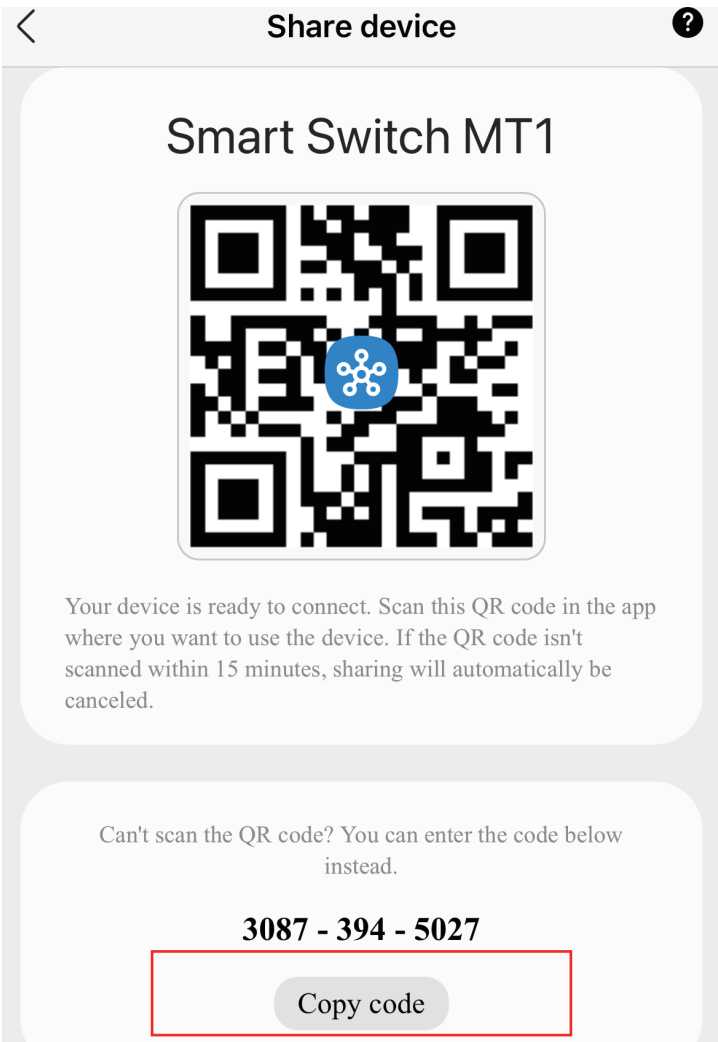
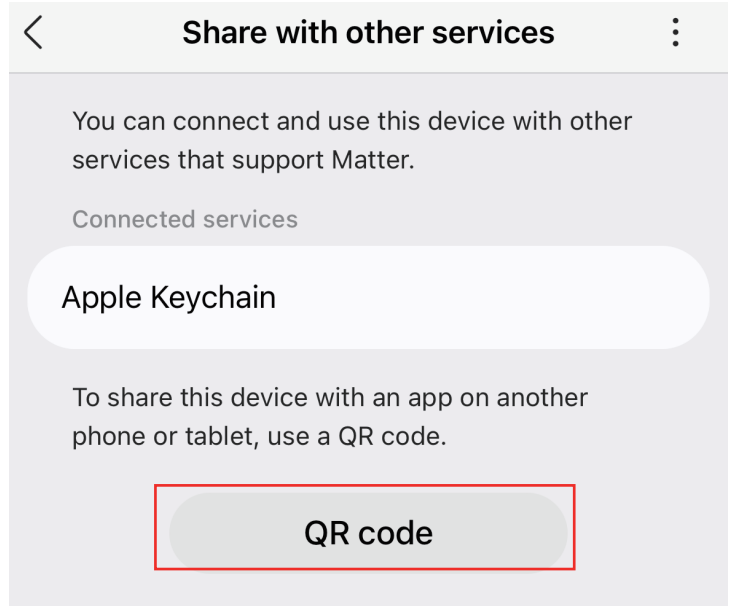
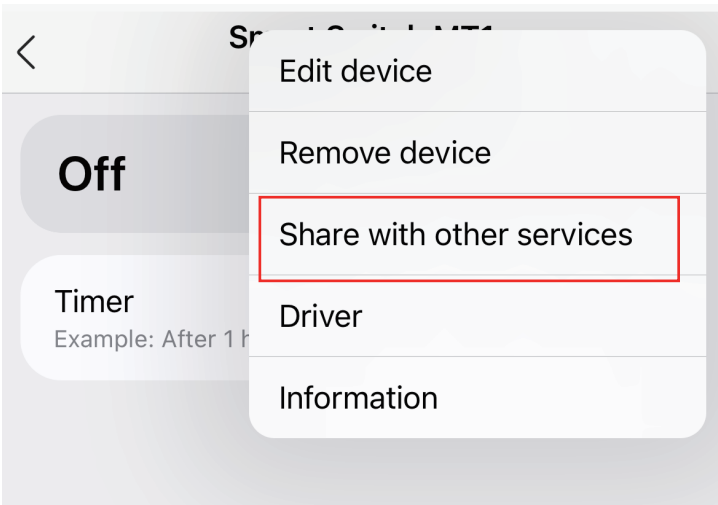
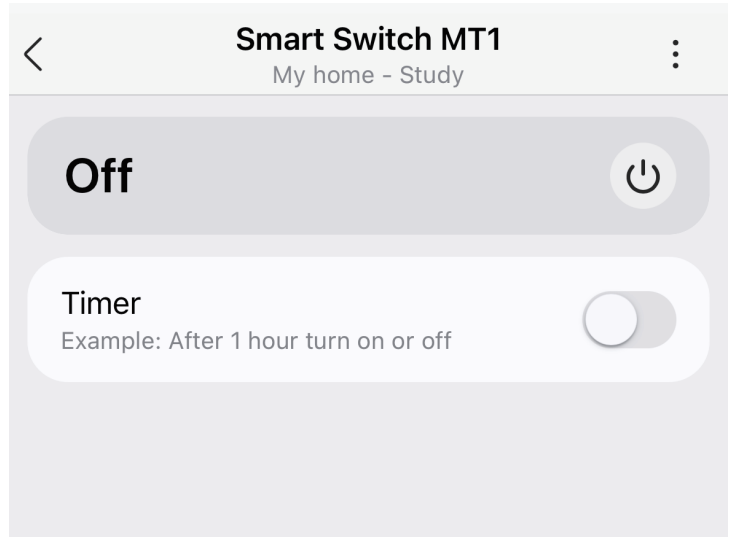
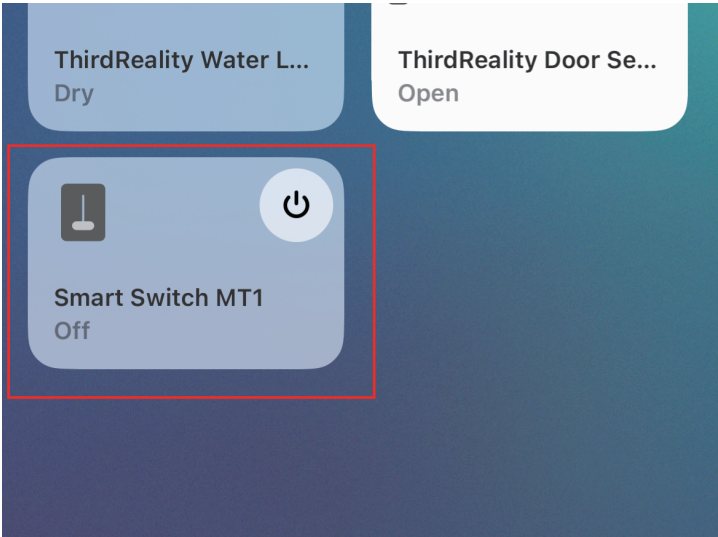

# Troubleshooting

## 1. Inverted On/Off status

To reverse On/Off direction of the switch, long press the Smart Switch button more than 10 seconds until blue LED is displayed solid then release.

## 2. Factory Reset

To factory reset the Smart Switch, press and hold the Smart Switch button more than 20 seconds until the blue LED flashed rapidly, indicating that the Smart Switch is in pairing mode now.

## 3. Adjusting/Adding Spacers

- If the Smart Switch actuates but is not turning your wall switch on or off, the gap between Smart Switch and wall switch may be too wide. Try slightly tightening faceplate screws. You can also try using a different size spacer.
- If Smart Switch fails to actuate or comes off the wall when actuating, the Switch may be too close to the wall. Try changing the size of your spacer.

# FCC Regulatory Conformance

This device complies with part 15 of the FCC rules. Operation is subject to the following two conditions: (1) this device may not cause harmful interference, and (2) this device must accept any interference received, including interference that may cause undesired operation.

Changes or modifications not expressly approved by the party responsible for compliance could void the user's authority to operate the equipment.

NOTE: This equipment has been tested and found to comply with the limits for a Class B digital device, pursuant to part 15 of the FCC Rules. These limits are designed to provide reasonable protection against harmful interference in a residential installation.

This equipment generates uses and can radiate radio frequency energy and, if not installed and used in accordance with the instructions, may cause harmful interference to radio communications. However, there is no guarantee that interference will not occur in a particular installation. If this equipment does cause harmful interference to radio or television reception, which can be determined by turning the equipment off and on, the user is encouraged to try to correct the interference by one or more of the following measures:

- Reorient or relocate the receiving antenna.
- Increase the separation between the equipment and receiver.
- Connect the equipment into an outlet on a circuit different from that to which the receiver is connected.
- Consult the dealer or an experienced radio/TV technician for help important announcement.

NOTE: The manufacturer is not responsible for any radio or TV interference caused by unauthorized modifications to this equipment. Such modifications could void the user's authority to operate the equipment.

## **RF Exposure**

This equipment complies with FCC radiation exposure limits set forth for an uncontrolled environment.

This transmitter must not be co-located or operating in conjunction with any other antenna or transmitter.

## **Limited Warranty**

For limited warranty, please visit <https://3reality.com/faq-help-center/>. For customer support, please contact us at [info@3reality.com](mailto:info@3reality.com) or visit [www.3reality.com](http://www.3reality.com).

For question on other platforms, visit for corresponding platform's application/support platforms.